

LC-X1265P*1

FOR STANDBY POWER SUPPLIES.
 EXPECTED TRICKLE DESIGN LIFE: 10 - 12 YEARS
 AT 20°C ACCORDING TO EUROBAT.

VdS
 G199090

DIMENSIONS (MM)

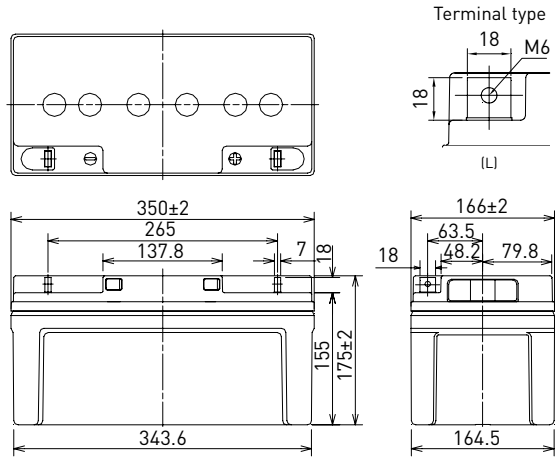

Contents indicated (including the recycle marking, etc.) are subject to change without notice.

Battery case resin: standard (UL94 HB)

SPECIFICATIONS		
Name	LC-X1265PG*1	
Nominal voltage	12V	
Nominal capacity (20 hour rate)	65Ah	
Dimensions	Length	350mm
	Width	166mm
	Height	175mm
Approx. mass	23.5kg	
Terminal	M6 bolt/nut	
Capacity (25°C)	20 hour rate	65Ah
	10 hour rate	60Ah
	3 hour rate	49Ah
	1 hour rate	40Ah
Impedance	Fully charged battery (25°C)	7mΩ
Temperature dependency of capacity (20 hour rate)	40°C	102%
	25°C	100%
	0°C	85%
	-15°C	65%
Self-discharge (25°C)	After 3 month	91%
	After 6 month	82%
	After 12 month	64%

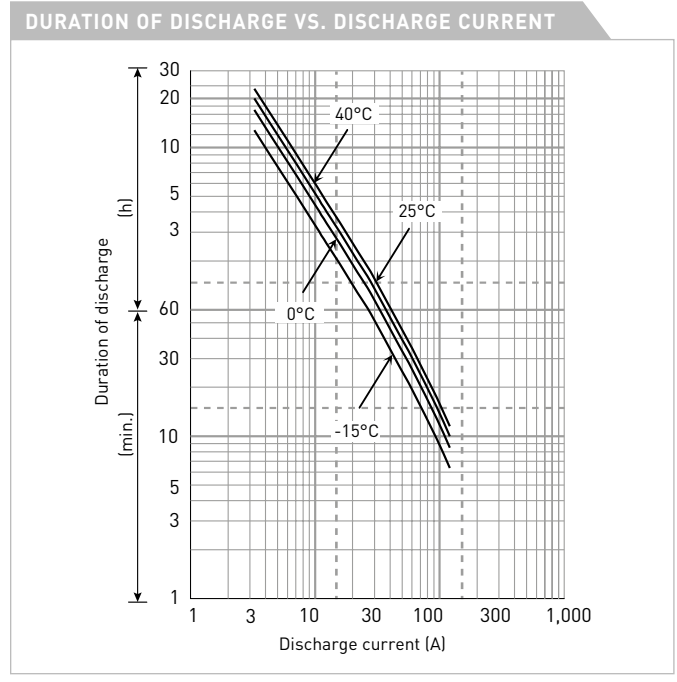

WATT TABLE (25°C)																(Wattage/battery)
Cut-off	5min.	10min.	15min.	20min.	30min.	45min.	1h	1.5h	2h	3h	4h	5h	6h	10h	20h	
9.6V	1,884	1,439	1,127	956	742	533	501	321	290	201	158	131	115	70.80	39.00	
9.9V	1,851	1,422	1,116	951	734	520	494	313	289	198	157	127	114	70.40	39.00	
10.2V	1,735	1,386	1,093	935	725	515	484	307	281	196	156	126	113	70.10	38.90	
10.5V	1,554	1,284	1,017	888	709	507	474	300	272	193	154	125	112	69.70	38.80	
10.8V	1,374	1,145	949	865	685	499	465	292	259	189	152	122	111	69.00	38.60	

AMPERE TABLE (25°C)																(Ampere/battery)
Cut-off	5min.	10min.	15min.	20min.	30min.	45min.	1h	1.5h	2h	3h	4h	5h	6h	10h	20h	
9.6V	195	129	98.0	82.4	63.4	45.4	42.2	27.2	24.5	16.9	13.2	11.1	9.60	6.05	3.27	
9.9V	193	127	97.0	82.0	62.7	44.3	41.6	26.5	24.4	16.6	13.1	10.8	9.56	6.02	3.27	
10.2V	183	124	95.0	80.6	62.0	43.9	40.8	26.0	23.8	16.4	13.0	10.7	9.52	5.99	3.26	
10.5V	166	115	88.4	76.6	60.6	43.2	40.0	25.4	22.9	16.2	12.9	10.6	9.41	5.96	3.25	
10.8V	150	102	82.5	74.5	58.5	42.5	39.2	24.7	21.9	15.8	12.8	10.3	9.26	5.90	3.23	

All mentioned values are average values

LC-X1265P*1

CHARGING METHOD (25°C)

Trickle use Control voltage: 13.6V - 13.8V
Initial current: 9.75A or smaller

CUT-OFF VOLTAGE

Discharge current	3.25A - 13.0A	13.0A - 32.5A	32.5A - 65.0A	65.0A - 130A	130A - 195A
Cut-off voltage	10.5V	10.2V	9.9V	9.3V	8.7V

INFLUENCE OF TEMPERATURE ON TRICKLE LIFE

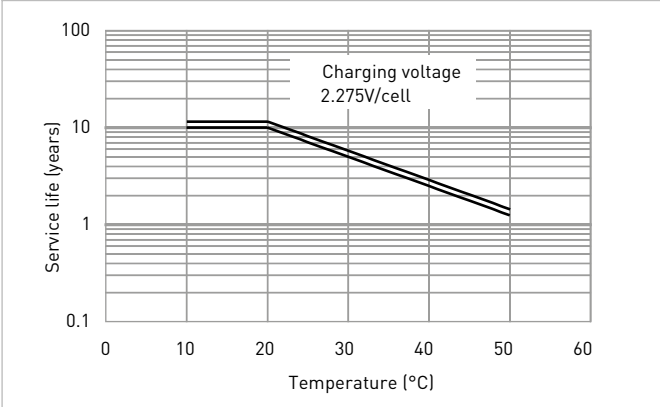

RESIDUAL CAPACITY TEST RESULT

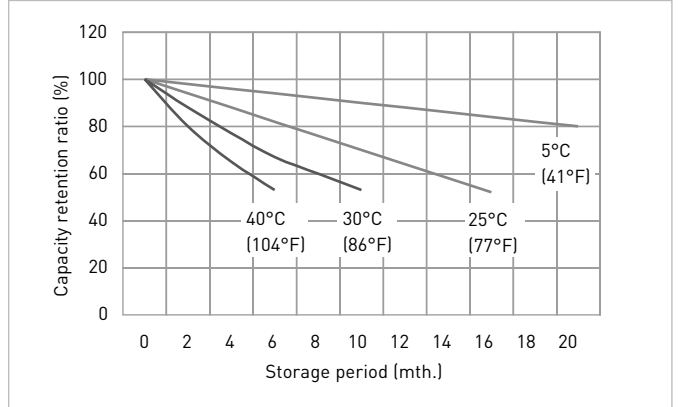

CONSTANT-VOLTAGE CONSTANT-CURRENT CHARGE CHARACTERISTICS FOR TRICKLE USE

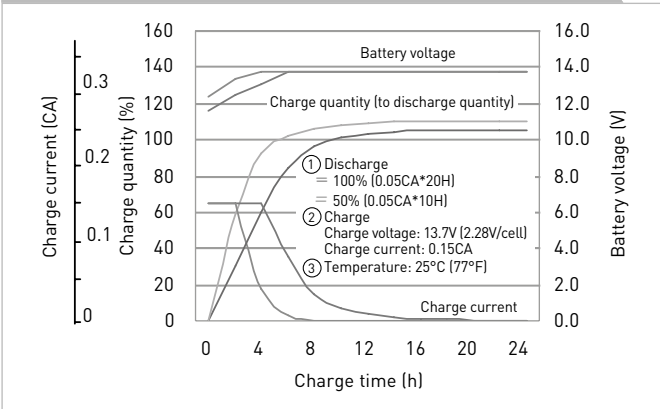

DISCHARGE CAPACITY BY TEMPERATURE AND BY DISCHARGE CURRENT

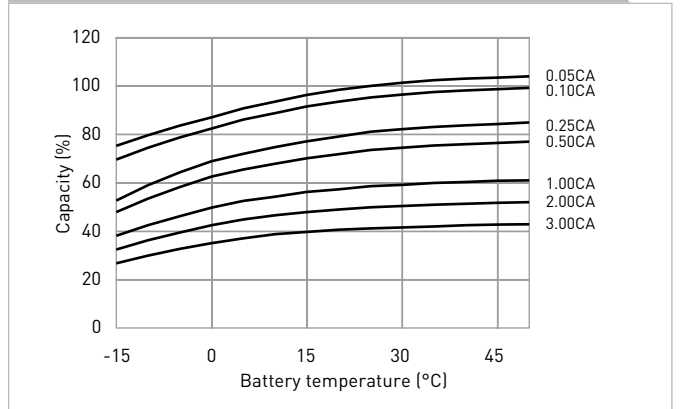

DISCHARGE CHARACTERISTICS

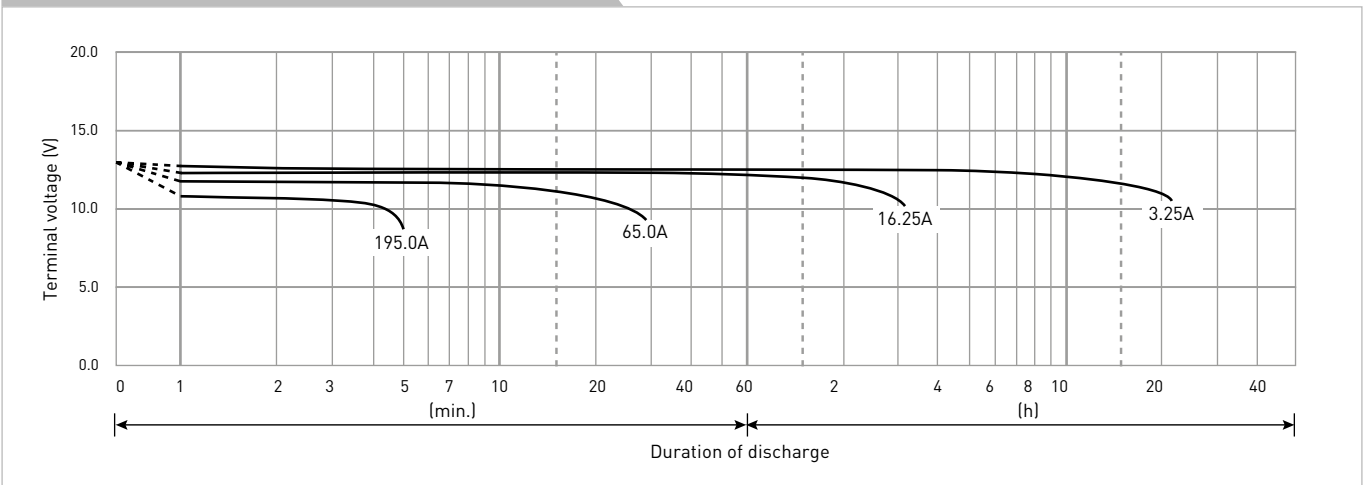

The data in this document are for descriptive purposes only and are not intended to make or imply any guarantee or warranty. Regarding handling and safety please consult our VRLA technical handbook chapter 1.

*1 This battery is also available with a flame retardant battery case resin (UL94 V-0): LC-P1265PG.